

FSG TYP Mini, 1,2,3

Anschrauben der Winkel - (Standardbestückung)

benötigtes Werkzeug

10er Drehmoment-Schlüssel

Moosgummi 2mm stark
20 x 30 cm
zum Überkleben der fertig
eingestellten FSG zum
Schutz vor Verkratzen.

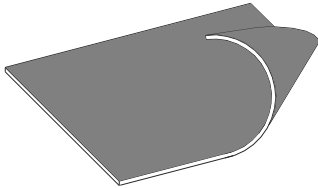

mitgeliefertes Zubehör:

① 4 x Winkel 50/70 x 80

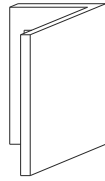

② 2 x Winkel 50/50 x 80

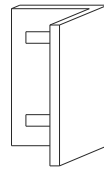

③ 6 x Winkel 50/50 x 50

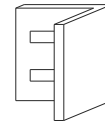

24 x Schlossschraube 6x20

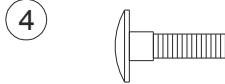

24 x Beilagscheibe 6,4mm



24 x Sicherungsmutter M6



4 x Klebeetikett "Mindestabstand 3cm"

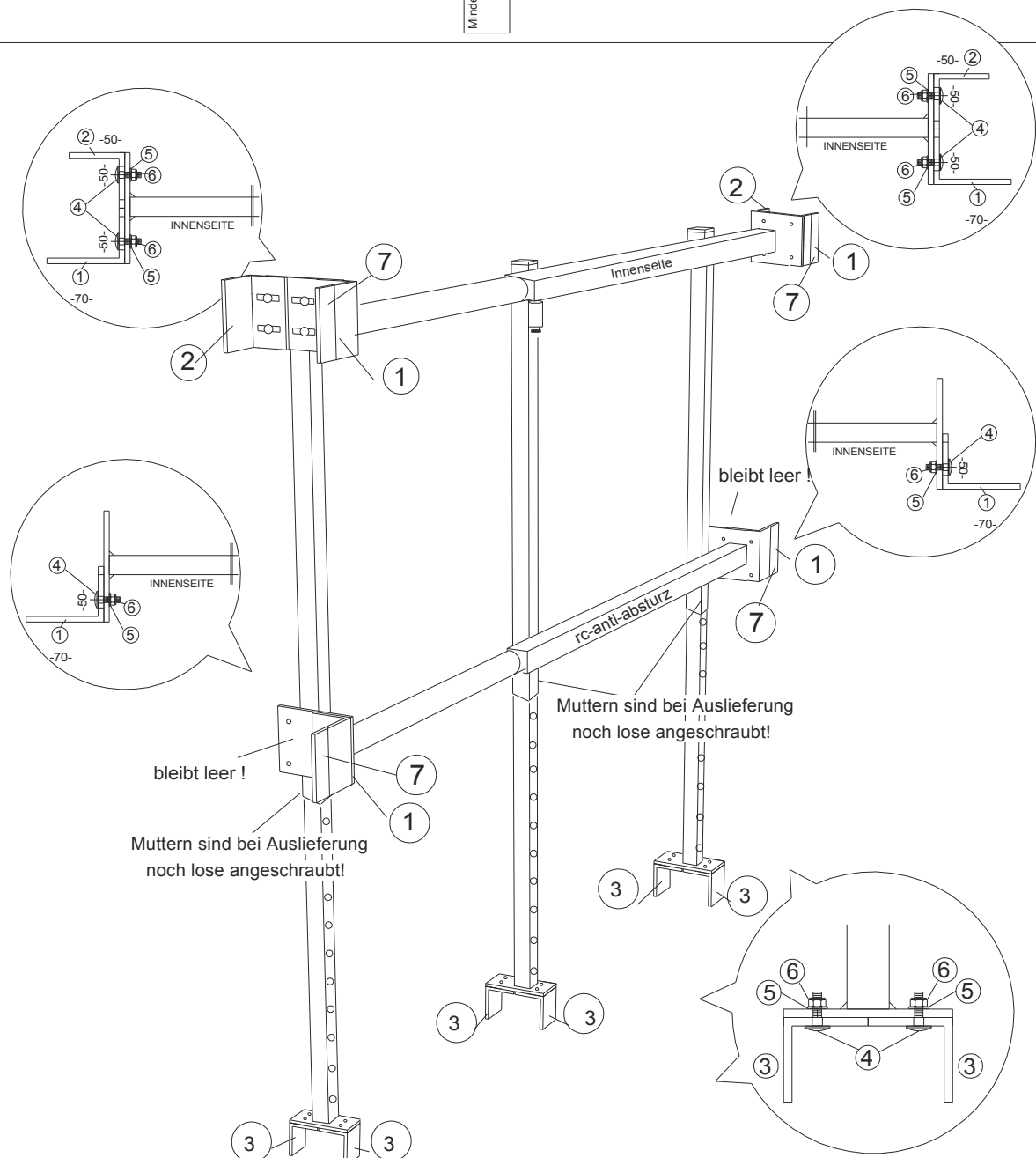
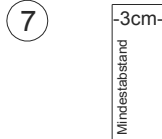

Aufbau- und Verwendungsanleitung beachten!